



**A.H. BEARD<sup>®</sup>**  
**Health Rest**



*Xperience*



---

**ADJUSTABLE BASE  
OWNER'S MANUAL**

# table of contents

Safety Precautions and Usage Statements .....	1-2
Parts List .....	3
Base Overview .....	4
Quick Reference Guide .....	5
Installation Guide .....	6-8
Divided Queen Installation Guide .....	9
Remote Control .....	10-11
Headboard Bracket Installation Guide .....	12-13
Emergency Power Down Box .....	14
Pair Remote .....	15
Setting Up Two Bases .....	16-17
Troubleshooting .....	18
Notes .....	19-21

# safety precautions and usage statements

## Attention: Important Safety Precautions

**Read all instructions before using your adjustable base. Save these instructions.**

### To reduce the risk of shock, burns, fire or injury:

Always unplug the base from the electrical outlet before servicing any part of the base. To reduce risk of electric shock, unplug the base before cleaning. To safely disconnect, ensure the base is in a flat position with all motors off, and unplug from power source.

Keep the power cord away from heated surfaces. Never operate the base when the air openings are blocked. Keep air openings free of lint, hair and the like. Do not drop or insert any object into any opening.

Discontinue use of the bed base and contact a qualified service centre if: it has a damaged cord or plug, if the cord is not working properly, or if the cord has been dropped into water.

Only use this bed base for its intended use as described in this manual. Do not use accessories/attachments that are not recommended by the manufacturer.

Close supervision is required when the bed base is used by or near children, convalescents or disabled persons.

### Outlet Safety:

**For optimal safety and operation, plug bed base into a surge protector (not included).**

The bed base should only be plugged directly into a wall outlet or surge protector (strongly recommended). Improper connection of the equipment can result in the risk of electrical shock, electrical fire or faulty operation of this bed base. If the plug does not fit your outlet, contact a qualified electrician to install a suitable outlet. Unauthorized modification or failure to use a wall outlet or surge protector could void the electrical portion of your warranty.

### Warranty Warning:

Do not open or tamper with control box, motors, or remote (with the exception of battery compartments). The warranty will be void if the internal workings of these components are tampered with. For complete warranty information visit [www.ergomotion.com](http://www.ergomotion.com) or refer to the warranty card included with the base.

### In-Home Use and Hospital Disclaimer:

Ergomotion adjustable bed bases are designed solely for in-home use. This base was not designed as a hospital bed and is not designed to meet hospital standards. Do not use this base with **TENT TYPE** oxygen therapy equipment or near explosive gases.

### Pacemaker Notice:

It is possible that some pacemakers may falsely interpret the optional massage feature vibrations as movement/exercise. This is a common occurrence with any product that creates a vibrating movement and may affect the pacemaker. Please consult your physician before using the massage feature.

### Pets and Small Children:

Immediately dispose of all packing materials as it may pose a smothering risk to small children and pets. To avoid injury, it is not advised to allow children and small pets to play on or under the bed. Children should not operate the bed base without adult supervision.

### Safety Features:

Casters (optional leg accessory) are equipped with locking wheels to prevent unwanted movement. Even when locked and unable to roll, it is possible for the casters to slide. Free release head and foot motors are designed to lower the mattress by retracting only with gravity, never pulling downwards, which minimizes pinch points.

# safety precautions and usage statements

## **Product Ratings:**

The lift motors are not designed to operate continuously for more than [2] minutes in an [18] minute time period or approximately 10% duty cycle. Attempting to circumvent or exceed this rating will shorten the life expectancy of the product and may void the warranty.

## **Weight Limits:**

This product is not rated to support weights exceeding 385 kg. This product is not rated to support weights in excess of 385 kg inclusive of the mattress and bedding. The base will structurally support this weight, provided it is evenly distributed across the bed base. The adjustable base is not designed to support or lift this amount in the head or foot sections alone. Exceeding this weight restriction could damage the bed and/or cause injury and will void the warranty.

## **Acoustics:**

The massage function will emit a noticeable tone during operation. As the massage intensity level is increased, the tone will intensify. The volume of this tone is directly related to the location environment. For example, when demonstrated in a show room, the surrounding environmental noise will cover some of the massage noise. However, when installed in a home setting with wooden floors, carpeted or not, the massage volume will be more noticeable. In normal base operation, the wheels which allow the bed to maintain its distance from the wall, will make contact with the steel platform supports of the base creating a contact noise. When entering, exiting or shifting weight on the base, this contact noise may be audible as the wheels make contact. This is normal.

## **Fabric Care:**

To prolong the life of your fabric, protect from direct sunlight whenever possible. For spot cleaning, wipe area with a light damp sponge or vacuum with a soft brush attachment to remove particles. Keep at a minimum of 30cm (12 inches) away from direct heat sources.

For deeper cleaning, blot liquid spills with a clean dry cloth. Wipe with a clean cloth dampened with warm water. **Do not wet excessively.** A soft bristle brush may be used to remove ingrained soil. Avoid scratching by gentle brushing. Wipe with a clean cloth dampened with water to remove residues. Dry in shade away from direct heat.

If persistent marks remain visible after cleaning, seek professional advice.

**SAVE THESE INSTRUCTIONS.**

# parts list

**Before discarding the packing materials- ensure all the parts are accounted for.**

All electronics and components that need to be installed are located in boxes under the base or attached to the frame.

- A) Wireless Remote Control (1) and AAA batteries (3)
- B) Clip Lock Attachment (2)
- C) Legs (4)
- D) Power Cord (1)
- E) Power Supply (1)
- F) Power Down Box (1)\*
- G) Connecting Strap\*†
- H) SmartSync™ Cord (1) †
- I) Metal C-Clamps (2)
- J) Long Bolts (4)
- K) Metal Washers (8)
- L) Nyloc Nuts (4)
- M) Hex Key (1)
- N) 13mm wrench (1)

**Shroud Kit Components:**

- O) Head Shroud Piece (1)
- P) Foot Shroud Piece (1)
- Q) Side Shroud Pieces (2)

**Misc Parts (not included):**

- R) Surge Protector (1)
- S) 9 Volt Batteries (2)
- T) Screwdriver (1)

\* These items are attached to the base for shipping purposes. Carefully remove from base and set aside.

† Only included in Long Single and Super King Split bases.

A) 		B)* 		C) 	
D) 		E) 		F)* 	
G)* † 		H) † 		I) 	
J) 	K) 	L) 	M) 	N) 	
<b>SHROUD KIT COMPONENTS</b>					
O) 		P) 		Q) 	
<b>MISC-NOT INCLUDED</b>					
R) 		S) 		T) 	

# base overview

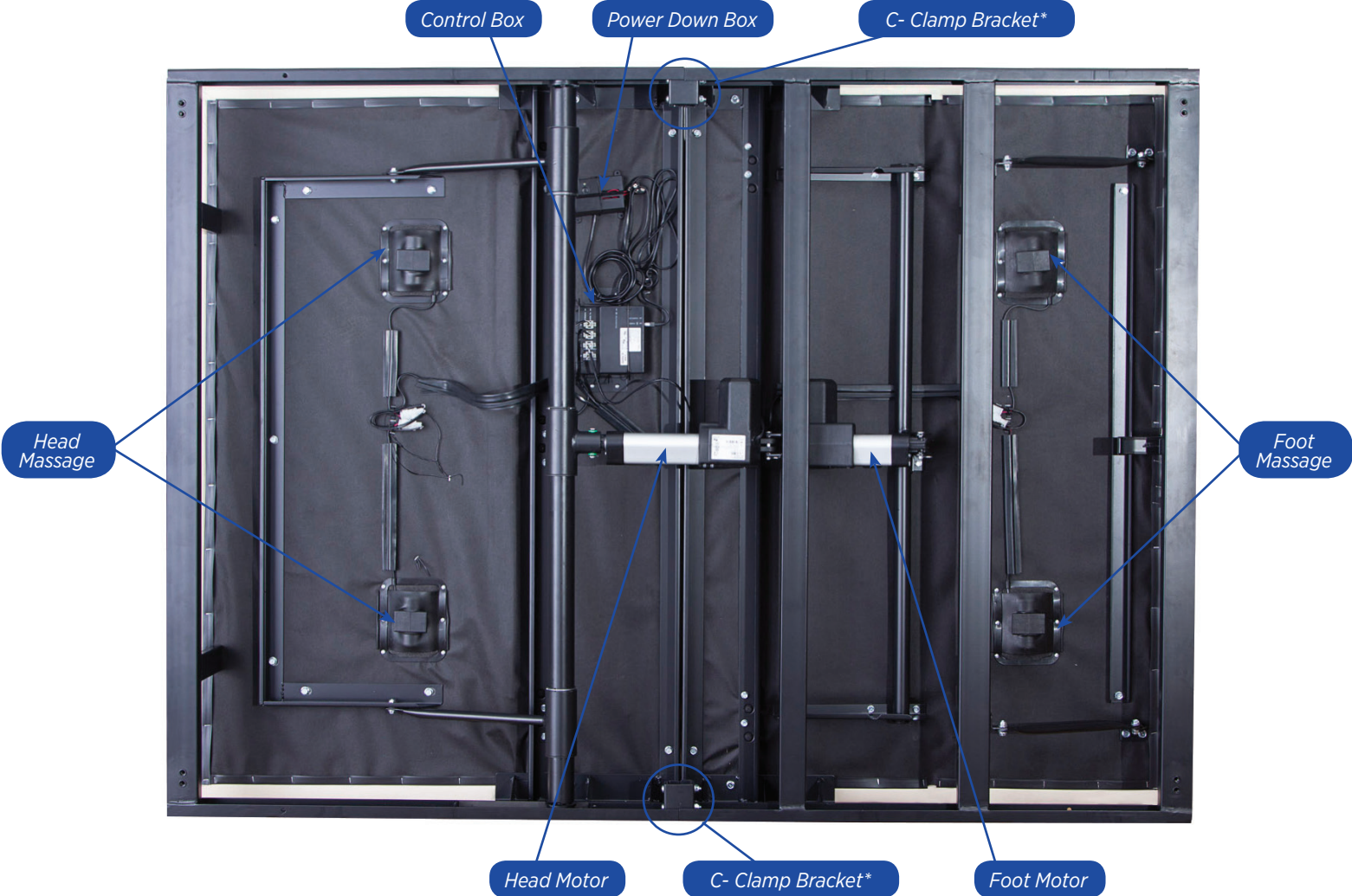

# quick reference guide

**Not to scale. For illustration purposes only. Read all instructions before beginning installation.**

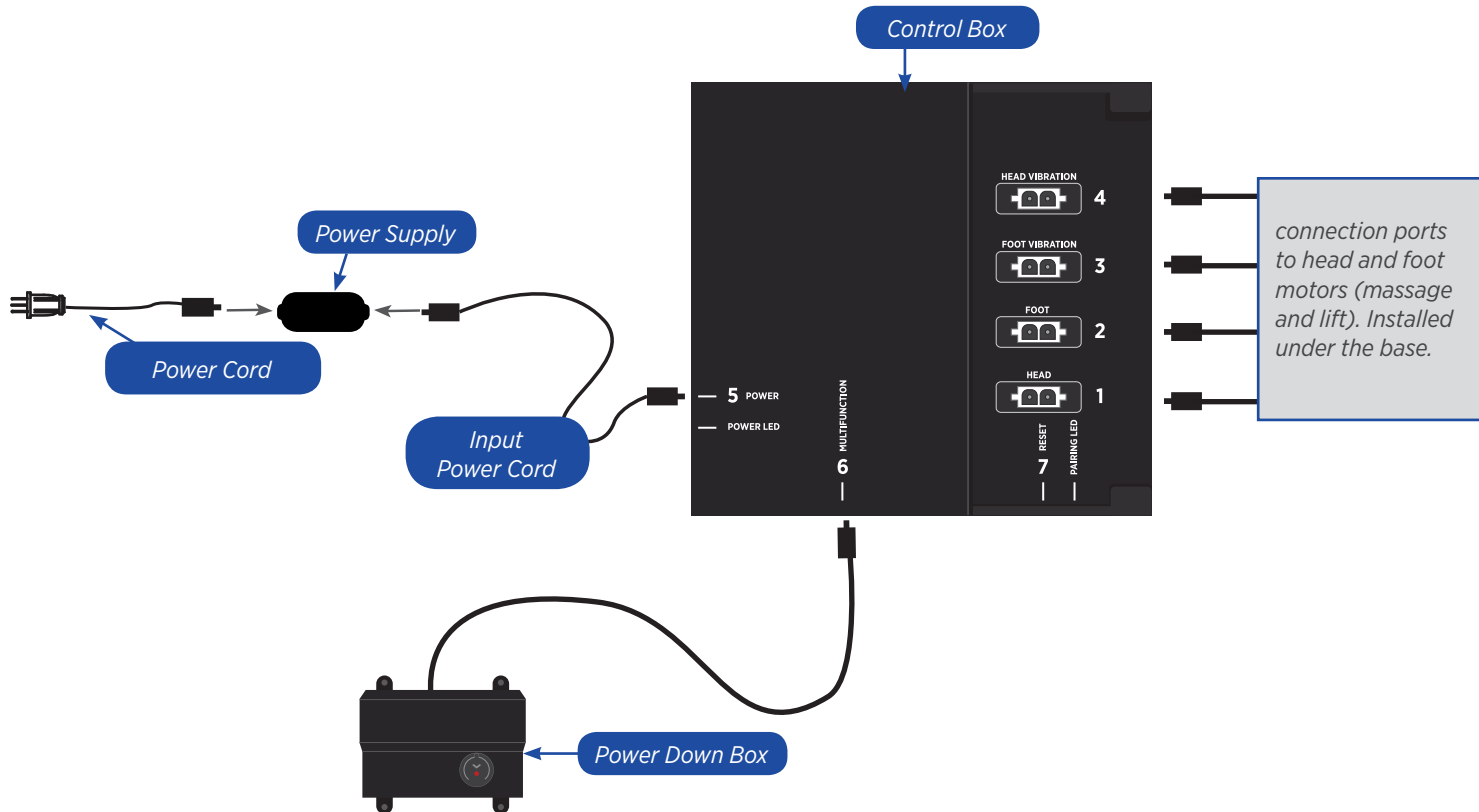

# installation guide

**Always use two people when setting up the base.**

**A Phillips head screw driver is required to complete base installation. Screwdriver is not included.**

## STEP 1

Place the bed base box(s) in a desired location with the bottom of the box(s) facing up. Make sure setup area is clean and there is plenty of space.

Remove the binding straps and packing materials, making sure not to puncture the box with any sharp objects.



## STEP 2

Remove the bed base from the box keeping the bottom of the base facing upwards.

Remove the electronics and leg box from the base. Set aside.

*\*Accessories, parts and legs are located in the foot sections of the Divided Queen Base.*

## STEP 3

**To install a Divided Queen base: See detailed installation instructions on page 9.**

**To install headboard brackets: See detailed installation instructions on page 12-13.**

To install the legs, thread the washer over the bolt of the leg with the recessed side facing the leg, and tighten by hand. **Do not over tighten.**



## STEP 4

**To sync two bases with the SmartSync™ cord - see page 14-15.**

Uncoil the Power Down Box from the frame and install (2) 9 Volt batteries- not included.

Place box on the ground. Ensure that it is easily accessible when the base is turned to its upright position.

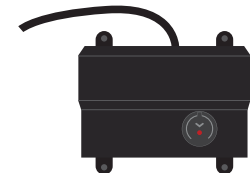

**For customer support, visit [www.ahbeard.com](http://www.ahbeard.com) or call: 1300 654 000**



# installation guide

## STEP 5

Uncoil input cord (connected to control box's power port) and plug into Power Supply.



## STEP 6

Uncoil the Power Cord and connect to the Power Supply. Place Power Supply on the ground and extend from the base. Ensure that the Power Supply and all attached cords are directed toward the desired surge protector.



## STEP 7

Carefully flip the base over on to its legs.

**Important:** Two people are required to move the bed base. Do not drag across the floor. Do not rest frame on its side, excessive pressure may damage the legs.

## STEP 8

Open box containing shroud kit and remove all 4 pieces.  
*[Head shroud(1), foot shroud (1) and side shrouds (2). Refer to parts list on page 3]*

**NOTE:** Head and Foot section are different; make sure metal tabs on base are aligned with the sleeves on the shroud to determine which piece is for the head and foot.

## STEP 9

Slide **HEAD & FOOT SHROUD** pieces onto the metal tabs on base. Make sure all tabs on both ends are properly secured.



## STEP 10

Line up **SIDE SHROUD** so that the metal tab on each end is aligned with sleeve on the head and foot sections.



Push shroud into place; make sure all clips attach to frame of base. Repeat for other side of shroud.

For customer support, visit [www.ahbeard.com](http://www.ahbeard.com) or call: 1300 654 000

# installation guide

## STEP 11

Use the **CLIP LOCK** system to connect mattress to the base.

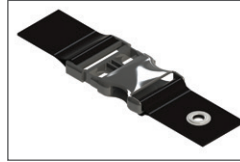

## STEP 12

Begin by removing both screws on platform of base using Phillips head screw driver.



## STEP 13

Attach female end of clip lock section to base.

Follow the bolting diagram to install the Clip Lock Strap. Repeat step for other side.

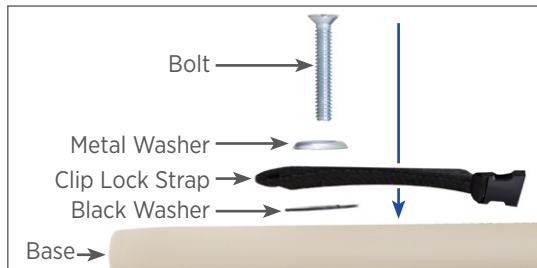

## STEP 14

Attach male end of clip lock system to mattress. Place mattress on base and secure with clip locks.



## STEP 15

Plug the base into a power source. **A surge protector is strongly recommended.**



## STEP 16

Ensure batteries are correctly installed in the back of the remote.

Quickly test functions to verify proper setup before placing mattress on base. Press **FLAT** to return the base to a flat position.



Basic setup is now complete! See page 10-11 for remote control operating instructions.

# divided queen installation guide

## STEP 1

Push head and foot sections together. Make sure the brackets on both sections are aligned properly.

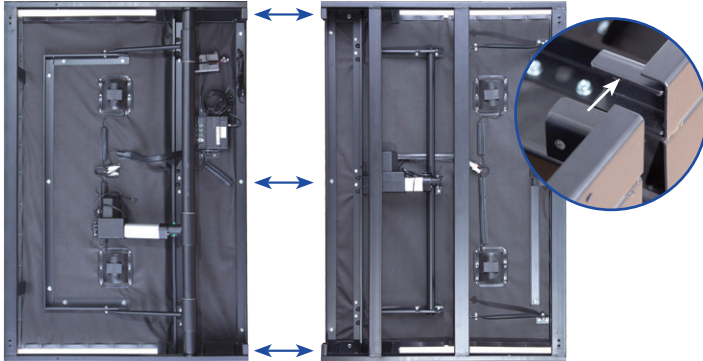

## STEP 2

Once aligned, locate the C-clamp and slide into place.

Secure the C-clamp onto the bracket with two bolts and nuts using provided wrench and hex key. Repeat on the other side.

**Note:** There should be one metal washer on each end of the bolt.



Washers



## STEP 3

Flip the head motor toward the foot of the base and secure to mounting bracket using cylinder pin and cotter pin.

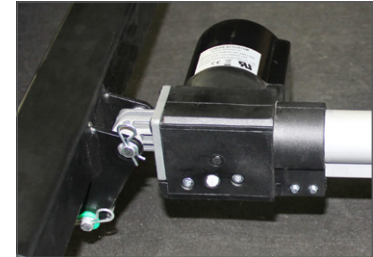
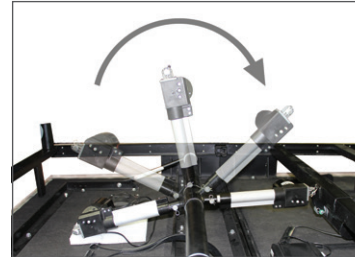

## STEP 4

Connect head motor, foot motor and massage motors into corresponding ports on control box. Secure excess wire into rubber conduit.

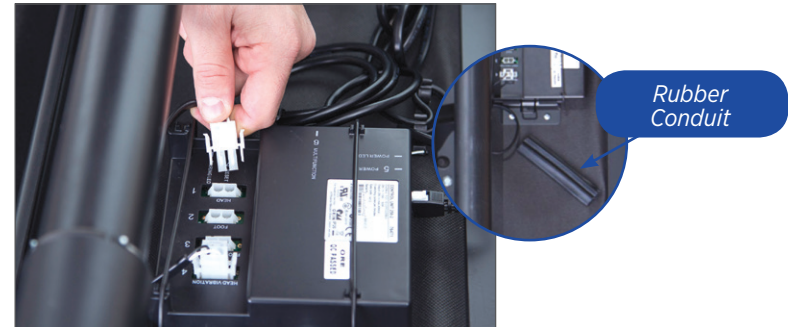

Divided Queen setup is now complete!  
Return to page 6, STEP 3 to complete base installation.

For customer support, visit [www.ahbeard.com](http://www.ahbeard.com) or call: 1300 654 000

# remote control

## REMOTE OVERVIEW

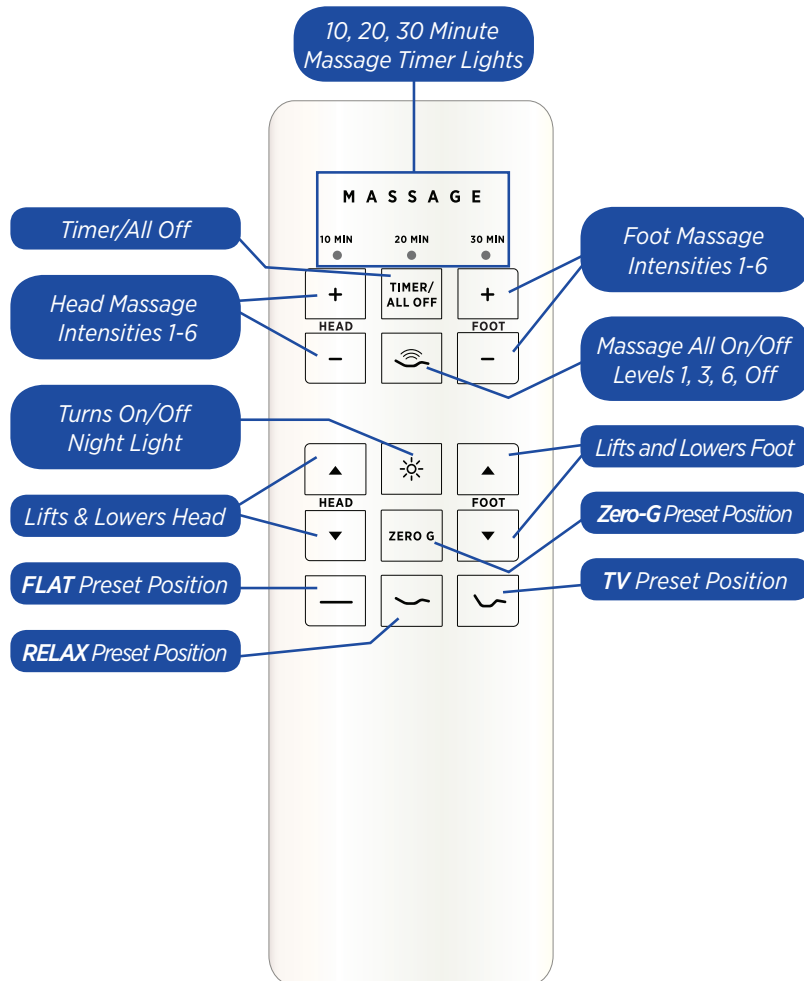

## MESSAGE FEATURE

**TIMER/ALL OFF** The **TIMER/ALL OFF** button starts massage at level 3. Select a 10, 20 or 30 minute message interval. Pressing a fourth time will turn off massage.

**10 MIN** The light on the top of the remote indicates a 10, 20 or 30 minute timer setting. Massage will automatically shut off after 10 minutes if the massage timer isn't set.

**MESSAGE** The **MESSAGE** button activates head and foot massage. Press to cycle through levels 1, 3, 6 and off.

**HEAD +** and **-** The **HEAD** + and - buttons adjust the head massage intensities. Levels 1-6.

**FOOT +** and **-** The **FOOT** + and - buttons adjust the head massage intensities. Levels 1-6.

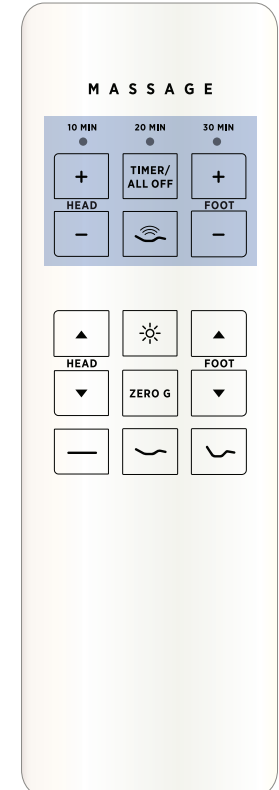

# remote control

## ADJUST



The HEAD ▲ ▼ arrows lift and lower the head section of the base.



The FOOT ▲ ▼ arrows lift and lower the foot section of the base.

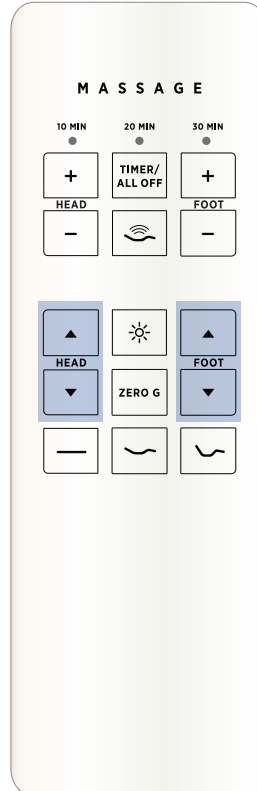

## ONE TOUCH BUTTONS



One touch ZERO-G preset position. Zero-G adjusts your legs to a higher level than your heart helping to relieve pressure off the lower back and promote circulation.



One touch FLAT preset position.



One touch RELAX preset position.



One touch TV preset position.





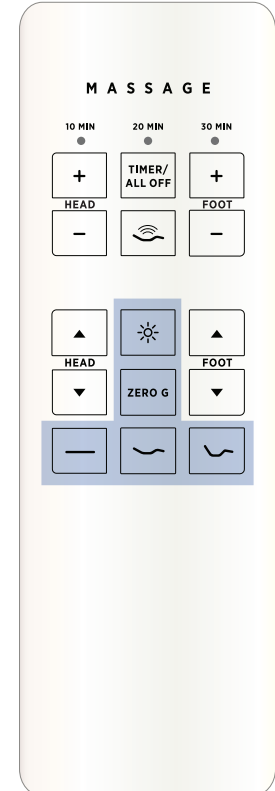



Turns On/Off underbed night light.



# headboard bracket installation guide (optional)

Headboard Brackets are an optional accessory and are not included.

A 14 mm & 13 mm" socket and crescent wrench are necessary to complete installation.

HEADBOARD BRACKET COMPONENTS					
Headboard Bracket (2) 	T-Bracket (2) 	Spacer (2) 	Long Bolt (8) 	Short Bolt (10) 	Nut (18) 

## STEP 1

- a.) Align the hole in the bracket to the brass sleeve into which the leg threads. Hold the bracket in place and screw the leg into the base until it is snug. **DO NOT OVERTIGHTEN.** Too much force may cause the leg to spin freely.
- b) Align the tab with the hole in the frame (located towards the foot of the base) and use a short bolt and nut to secure the bracket. Make sure the bolt is tight.



# headboard bracket installation guide (optional)

## STEP 2

Attach the plastic spacer and T-Bracket.

- a.) Measure the distance between the mounting holes on the headboard and install the spacer and attachment plate to accommodate the headboard.
- b.) To install the plastic spacer and attachment plate, you will need (2) long bolts and (2) nuts. Place the spacer and attachment plate in the desired location and slip the bolts through the holes with the head of the bolt facing outward. Position the bolts diagonally on the spacer. Use the 14 mm socket and wrench to tighten the bolts.

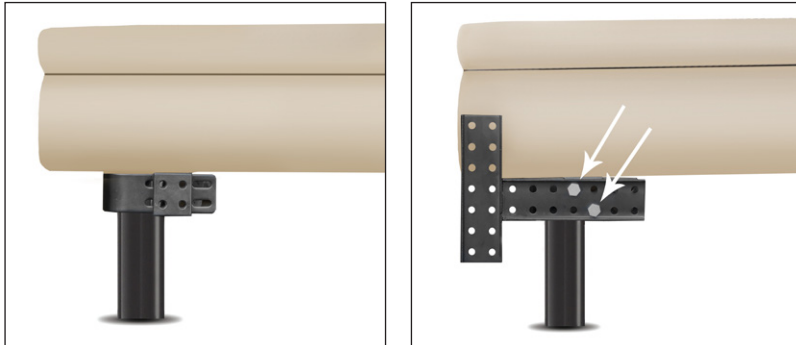

## STEP 3

You may now connect your headboard to the attachment plates using the remaining short bolts and nuts to secure it to the brackets. The heads of the bolts will face outward. Use a 14 mm socket and 13 mm wrench to tighten the bolts.

# emergency power down box

**In the event that the base is stuck in an articulated position during a power outage- the Power Down Box will return the base to a flat position.**

**(2) 9 Volt batteries are required to operate the power down feature and are NOT included.**

## STEP 1

Locate the Power Down Box under the base.

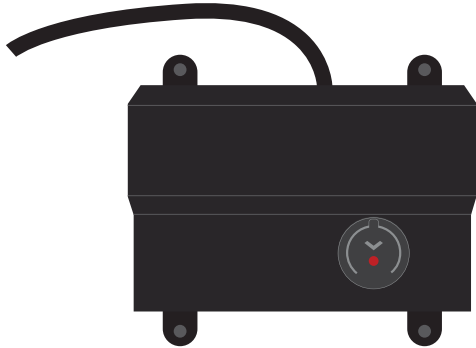

## STEP 2

Press and hold the button until the base is flat.

**NOTE:** The power down box button can be pressed at any time during the loss of power to return the base back into a flat position.

For emergency use only.

The Power Down Box can only be used to bring the base to a flat position. It will not bring the base to a flat position when the base is connected to a working power source.



# pair remote

The original remote that comes in the box is already paired to the bed base. No further action is required.  
In the event that the remote is not paired with the base, follow the steps below.

## STEP 1

Remove back cover from remote control. Remove and replace batteries.



## STEP 2

Double click the button on the Power Down Box (this will not cause the base to move). The light will illuminate.

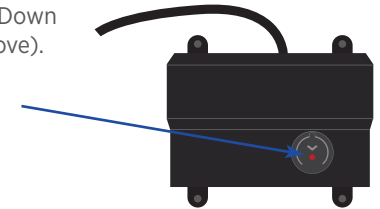

## STEP 3

Press and hold button on the back of the remote. The light will begin to flash then become a continuous solid light.

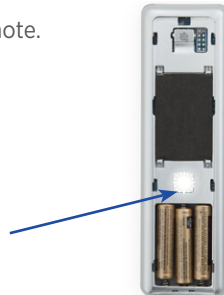

## STEP 4

Both lights on the Power Down Box and the Remote will be continuously lit, then simultaneously turn off. Replace back cover of the remote.



The remote is now paired with the base.

If the Power Down Box is not available - Remove back cover of the remote, locate the rubber button in the center of the back. On the control box located underneath the bed, double click the **RESET** button. Press and hold the back rubber button on the remote. The button will begin to flash then become a continuous solid light for 1 to 2 seconds and then turn off. Once the remote is paired, replace back cover of the remote and test base functionality.

# setting up two bases

**Connecting straps are secured to the base frame upon delivery.**

## OVERVIEW

If a split setup is being installed, plastic connecting straps are provided (one per base) to secure the bases together. Use both straps to secure the head and foot portions together.



## STEP 1

With the bases in their desired location, slightly loosen both legs to allow the strap to fit on the leg bolt, between the leg washer and frame.



## STEP 2

Slide side (a) of the connecting strap onto leg bolt. Swing the strap and connect side (b) to the leg bolt. Secure the strap by shifting to the left.



## STEP 3

Re-tighten legs. Do not over tighten. Use the remaining strap and repeat on other end of the base.

# setting up two bases

**If simultaneous operation of two bases is desired, use the SmartSync™ Cord to connect the electronics of both bases together.**

## STEP 1

Unplug base from power source.

## STEP 2

Disconnect the power-down box cable from each control box. Make note where the cable was plugged in.

## STEP 3

Connect the male end of the sync cord to each control box. Insert the cord into the same port that you disconnected the power-down box from in Step 2.

## STEP 4

Connect each power-down box male connection to the sync cord female connection (Refer to the illustration below).

## STEP 5

Plug base back into the power source.

## STEP 6

Check to ensure all cords are securely attached. Both remotes will now operate both bases simultaneously (If the remotes become unpaired, see page 15).

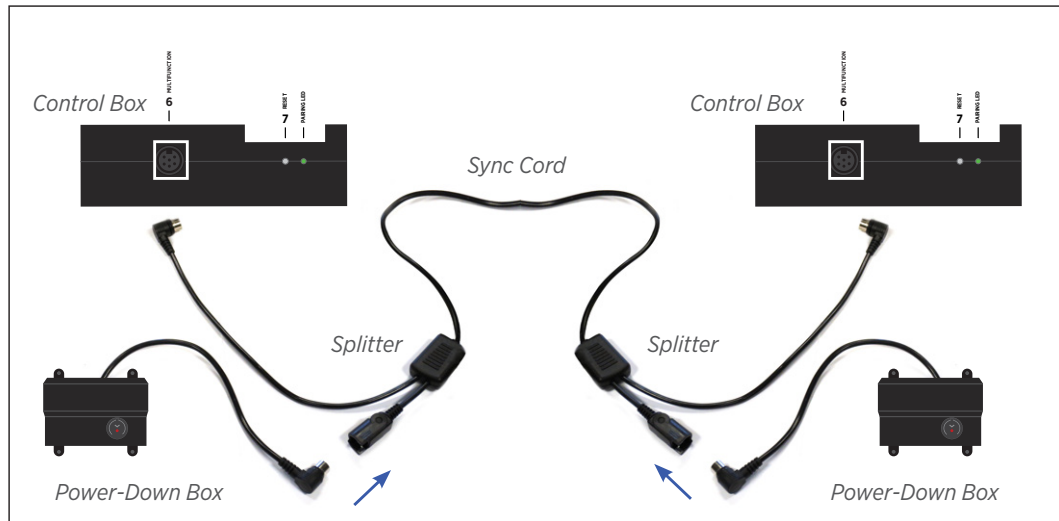

## **If one or more functions on the bed base have stopped operating:**

- Check under the bed base to verify that the wired connections are secure and that there are no cords or bedding obstructing the movement of the base.
- Check to ensure the green LED light is illuminated on the control box. If there is no light, verify that the input and power cords are properly connected.
- Unplug the base for 1 hour to reset the electronic components.
- Plug bed base into a different electrical outlet, or test current outlet with another working appliance (a grounded, electrical surge protector is recommended).

**If issue is not resolved by following the instructions above, locate serial number on warranty card or back of remote and contact AH Beard:**

**Phone: 1300 654 000 | E-mail: [serviceteam@ahbeard.com](mailto:serviceteam@ahbeard.com) | Web: [www.ahbeard.com](http://www.ahbeard.com)**

# notes

---

---

---

---

---

---

---

---

---

---

---

---

---

---

---

---

---

---

---

---

---

---

---

---





+

+

+

+

**CUSTOMER SERVICE:**

**Phone: 1300 654 000**

**Email: [serviceteam@ahbeard.com](mailto:serviceteam@ahbeard.com)**

**Website: [www.ahbeard.com](http://www.ahbeard.com)**

**A.H. Beard Pty Ltd  
38 - 60 Bryant Street  
Padstow NSW 2211**